



MOD-16

16x16 Modular Matrix

OPERATION MANUAL

DISCLAIMERS

The information in this manual has been carefully checked and is believed to be accurate. CYP (UK) Ltd assumes no responsibility for any infringements of patents or other rights of third parties which may result from its use.

CYP (UK) Ltd assumes no responsibility for any inaccuracies that may be contained in this document. CYP (UK) Ltd also makes no commitment to update or to keep current the information contained in this document.

CYP (UK) Ltd reserves the right to make improvements to this document and/or product at any time and without notice.

COPYRIGHT NOTICE

No part of this document may be reproduced, transmitted, transcribed, stored in a retrieval system, or any of its part translated into any language or computer file, in any form or by any means—electronic, mechanical, magnetic, optical, chemical, manual, or otherwise—without express written permission and consent from CYP (UK) Ltd.

© Copyright 2011 by CYP (UK) Ltd.

All Rights Reserved.

Version 1.1 August 2011

TRADEMARK ACKNOWLEDGMENTS

All products or service names mentioned in this document may be trademarks of the companies with which they are associated.

SAFETY PRECAUTIONS

Please read all instructions before attempting to unpack, install or operate this equipment and before connecting the power supply.

Please keep the following in mind as you unpack and install this equipment:

- Always follow basic safety precautions to reduce the risk of fire, electrical shock and injury to persons.
- To prevent fire or shock hazard, do not expose the unit to rain, moisture or install this product near water.
- Never spill liquid of any kind on or into this product.
- Never push an object of any kind into this product through any openings or empty slots in the unit, as you may damage parts inside the unit.
- Do not attach the power supply cabling to building surfaces.
- Use only the supplied power supply unit (PSU). Do not use the PSU if it is damaged.
- Do not allow anything to rest on the power cabling or allow any weight to be placed upon it or any person walk on it.
- To protect the unit from overheating, do not block any vents or openings in the unit housing that provide ventilation and allow for sufficient space for air to circulate around the unit.

REVISION HISTORY

VERSION NO.	DATE	SUMMARY OF CHANGE
v1.00	03/03/2015	First release
v1.01	25/03/2015	Added Modules Diagram
v1.02	07/04/2015	Added IR Remote & Pin-out Sections

CONTENTS

1. Introduction	6
2. Applications	6
3. Package Contents	6
4. System Requirements	7
5. Features	7
6. Operation Controls and Functions	8
6.1 Front Panel	8
6.2 Rear Panel.....	10
6.3 RS-232 Protocols	11
6.4 Remote Control	12
6.5 IR Cable Pin Assignment	13
6.4 RS-232 & Telnet Command.....	14
6.5 RS-232 & IP to RS-232 RX Output Configuration	16
6.6 Telnet Control.....	17
6.7 Web GUI Control	19
7. Connection Diagram	21
7.1 Example installation (16x16 HDMI Matrix)	21
7.2 Input and Output Modules	22
8. Specifications	23
8.1 Technical Specifications	23
8.2 Technical Specifications (Input Modules)	24
8.3 Technical Specifications (Output Modules).....	25
8.4 CAT5e/6/7 Cable Specification	27
9. Acronyms	28

1. INTRODUCTION





The 16x16 Modular Matrix is designed to allow the switching and distribution of up to 16 source devices to up to 16 connected displays, either directly via HDMI, DVI or via CAT5e/6/7 outputs to compatible receivers, providing control options (dependent on module configuration).

Providing unparalleled levels of flexibility, with an advanced modular design these models can be setup in a wide variety of combinations allowing users the ability to tailor the Matrix to their requirements by simply adding or removing the input or output modules as required.







The Modular Matrix is supplied with dual removable internal PSU's which allow for easy inspection and maintenance with zero down time. Also included is a DVI output for local monitoring of the output allowing installers to easily monitor, test, and configure the Inputs and Outputs on installation

In addition, this matrix also features IP control allowing users to access and control the matrix remotely and also allow additional options for integration of third-party control systems

2. APPLICATIONS

-  Public information display
-  Educational demo
-  Professional Presentation
-  Advertising display

3. PACKAGE CONTENTS

-  16x16 Modular Matrix Enclosure (including CPU control board & dual power supplies)
-  2x Input Module Board - HDMI/DVI/CAT5e/6/7 or VGA (Optional)
-  2x Output Module Board - HDMI/DVI/CAT5e/6/7 (Optional)
-  1x IR Blaster
-  2x IR Extender
-  2x Power Cord
-  Operation manual

4. SYSTEM REQUIREMENTS

- /// Up to 16 HDMI/DVI/CAT5e/6/7 or VGA source devices (dependent on module configuration) connected with appropriate cables.
- /// Up to 16 displays (TV or monitor) or AV receivers, equipped with HDMI/DVI/CAT5e/6/7 connection (dependent on module configuration) connected with appropriate cables
- /// Industry standard CAT5e/6/7 cable (for CAT5e/6/7 inputs/outputs)
- /// Compatible PoC HDBaseT™ Transmitters/Receivers for CAT5e/6/7 Input/Output modules

5. FEATURES

- /// HDMI, HDCP 1.1 and DVI 1.0 compliant
- /// Interchangeable input and output modules
- /// Input and output module types can be mixed and added in multiples of 8 from 8x8 (1 Input module, 1 Output module) up to 16x16 (2 Input modules, 2 Output modules) with HDMI, DVI, CAT5e/6/7 and VGA (Input Only) connection types
- /// Supports passthrough of LPCM 7.1CH, Dolby TrueHD, Dolby Digital Plus and DTS-HD Master Audio
- /// Supports a wide range of PC and HDTV resolutions from VGA to WUXGA and 480i to 1080p and 4Kx2K (dependent on module configuration)
- /// Supports control of the matrix via IR, RS-232, Telnet and Web GUI controls
- /// Dual removable power supply units, supports replacement without any matrix downtime
- /// Supports HDMI cable input and output lengths of up to 15m each way (1080p@8bit resolution) or 10m (1080p@12bit resolution)
- /// Supports 3 EDID modes:
 - *Standard mode*: Factory Default
 - *Automatic mode*: reads the EDID settings from the display connected to the lowest numbered output port
 - *Manual mode*: Can assign any input to any output port
- /// Supports CAT5e/6/7 cable input and output lengths of up to 100m (1080p) or 70m (4Kx2K) dependent on module configuration
- /// 5Play™ convergence: HD Video, HD Audio, PoC, Ethernet & Control (IR & RS-232)
- /// 4Play convergence: Video, Audio, PoC & Control (IR & RS-232)
- /// 3Play convergence: Video, Audio & Control (IR & RS-232)

6. OPERATION CONTROLS AND FUNCTIONS

6.1 Front Panel

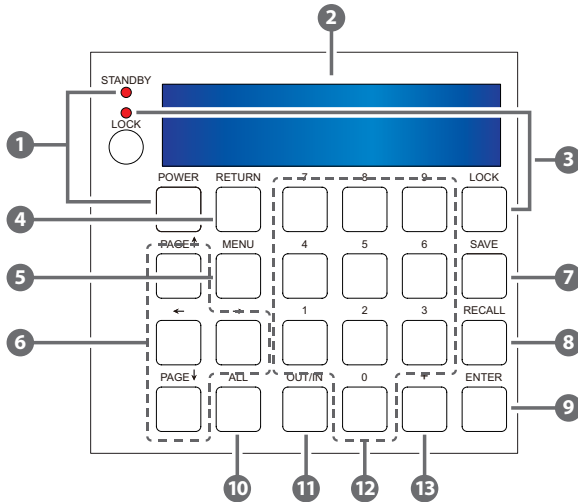

- 1 POWER button & LED:** Press this button to turn the device ON or press it again to put the device into standby mode. The LED will illuminate when the unit is in standby mode.

Note: If the LED is flashing it means the temperature inside is too high and air circulation may have been restricted.
- 2 LCM:** Displays the setting information of each input/output and other setting information according to the selected mode.
- 3 LOCK button & LED:** Press this button to lock all the function buttons on panel. The LED will illuminate, to unlock press it again.
- 4 RETURN:** Press this button to return back or exit the current selection.
- 5 MENU:** Press this button to enter the menu to change the following settings:

 - A. *EDID*
 1. *Standard Mode:* Uses the built-in EDID settings that support video up to 1080p@60/WUXGA@60RB and LPCM 2CH audio
 2. *Automatic Mode:* Reads the EDID settings from the display

connected to the lowest numbered output port.

3. *Manual Mode*: Supports independent EDID settings by selecting the input and output ports.

B. *IP*

1. IP address,
2. Netmask,
3. Gateway.

C. *Temperature*

1. Temperature 1
2. Temperature 2

NOTE: these figures show the internal temperature of the device.

D. *LCM Contrast Range from 1~4*

- 6 **PAGE** ▲ ▼ ◀ ▶: Use these buttons to cycle through the LCM's pages for displaying the current I/O status or when entering into the settings menu.
- 7 **SAVE**: Press this button to store the present Input/Output configuration to one of the 8 available preset settings.
- 8 **RECALL**: Press this button to recall a previously stored preset setting.
- 9 **ENTER**: Press this button to confirm a setting or selection in the menu.
- 10 **ALL**: Press this button to assign the same input to all outputs.
- 11 **OUT/IN**: Press to assign the source to be displayed on the required output. The sequence should be OUT/IN→Select the Input→OUT/IN→ Select the output→Enter.
- 12 **0~9**: Use to select the appropriate numbered input or output.
- 13 **+ (Plus)**: Press this button when multiple outputs are required for a selected input. This button only works in conjunction with the OUT/IN button.

6.2 Rear Panel

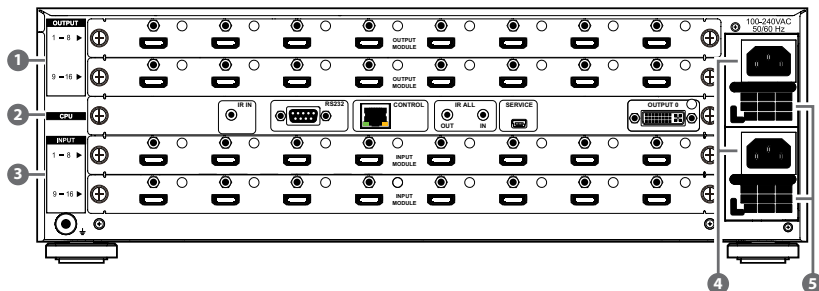

Note: The above panel is an example of a 16x16 HDMI configuration.

- 1 OUTPUTS 1~16:** Install up to 2 Output modules as required for up to 16 display or CAT5e/6/7 outputs (dependent on module configuration).
- 2 CPU (Control Board)**

IR IN: For control of the matrix only. Connect to the IR extender for IR signal reception of the IR remote control of the matrix. Ensure that the remote being used is within the direct line-of-sight of the IR extender.

RS-232: Connect with a D-Sub 9-pin cable to a PC/Laptop device or RS-232 Control system for RS-232 control of the Matrix or RS-232 compatible devices connected to CAT5e/6/7 receivers.

CONTROL: Connect to an active network for LAN serving and Telnet/ Web GUI control. (LAN serving on compatible HDBaseT input/output modules and transmitter/receivers only)

ALL IR OUT: Connect to the IR blaster for IR signal transmission of the source or display equipment. Place the IR blaster in direct line-of-sight of the equipment to be controlled.

ALL IR IN: Connect to the IR extender for IR signal reception of the remote control of this device or the source and display equipment. Ensure that remote being used is within the direct line-of-sight of the IR extender.

SERVICE: This port is reserved for firmware update only.

OUTPUT 0: Connect to DVI equipped display or to an HDMI equipped display (with DVI to HDMI adaptor) for local monitoring of the output signal.

- ③ **INPUT 1~16:** Install up to 2 Input modules as required for up to 16 source devices or CAT5e/6/7 inputs (dependent on module configuration).
- ④ **POWER & POWER Supply:** The device will automatically turn ON when connected to an active power supply.
- ⑤ **Ventilation Fan:** This fan will automatically operate when the device is switched ON. Do not block the exhaust of the fan or cover it with any object. Please allow adequate space around the unit for air to circulate freely.

6.3 RS-232 Protocols

Matrix			RS-232 Controller	
PIN	Definition		PIN	Definition
1	NC	→	1	NC
2	TxD		2	RxD
3	RxD		3	TxD
4	NC		4	NC
5	GND		5	GND
6	NC	←	6	NC
7	NC		7	NC
8	NC		8	NC
9	NC		9	NC

Baud Rate: 19200bps

Data Bit: 8 bits

Parity: None

Stop Bit: 1

Flow Control: None

6.4 Remote Control

- 1 **Power:**
Press this button to switch on the device or set it to standby mode
- 2 **OUTPUT:**
Output port selection
- 3 **CLEAR:**
Press to clear the present input/output selection
- 4 **ENTER:**
Press to confirm the present input/output selection
- 5 **INPUT:**
Input port selection

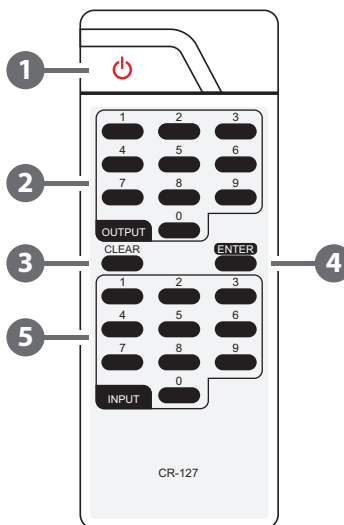

IR Control:

From the front panel:

1. Select the output zone (1–16)
2. Select the input source (1–16)
3. Press enter to confirm

From the zone:

1. Select the input source (1–16)
2. Press enter to confirm

6.5 IR Cable Pin Assignment

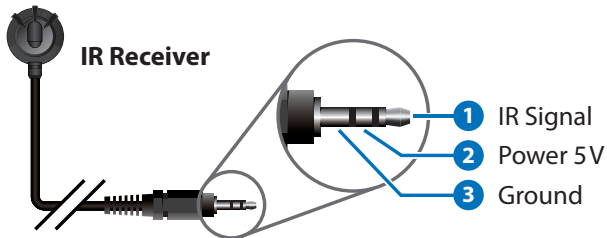
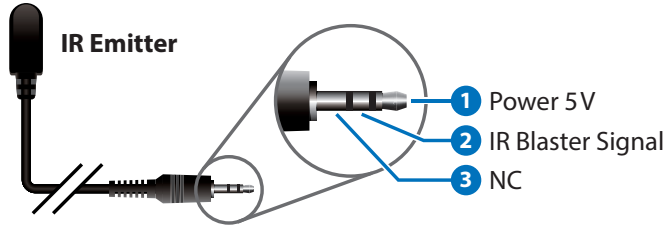

6.4 RS-232 & Telnet Command

HELP: Show Command list.

Command	Description
P1	Power on.
P0	Power off.
Oxly	Set Output (x:0~32) to Input (y:1~32).
ALLOUT x	Set all outputs to input (x:01~32).
ACTIVE	Report active I/O channels.
INDETECT	Input channels detection indicator.
OUTDETECT	Output channels detection indicator.
PORTSTATUS	Report all output connection status.
HDCPON x	Set input port(x:01~32) HDCP to ON.
HDCPOFF x	Set input port (x:01~32) HDCP to OFF.
HDCPONALL	Set ALL input port's HDCP to ON.
HDCPOFFALL	Set ALL Input port's HDCP to OFF.
HDCPSTATUS	Show the HDCP status of all outputs (0=disabled,1=enable).
MUTEO x	Mute video for output (x:0~32)
UNMUTEO x	Unmute video for output (x:0~32)
MUTEI x	Mute video for input (x:0~32)
UNMUTEI x	Unmute video for output (x:0~32)
MUTEALL	Mute all outputs.
UNMUTEALL	Unmute all inputs.
MUTESTATUS	Show the mute status of all outputs (0=unmuted,1=muted).
HPDL x	Pull the input (x:01~32) Hot Plug Detect signal to 'LOW'.
HPDH x	Pull the input (x:01~32) Hot-Plug-Detect signal to 'HIGH'.

Command	Description
HPDLALL	Set the Hot-Plug-Detect of all inputs to Low.
HPDHALL	Set the Hot-Plug-Detect of all inputs to High.
HPDSTATUS	Report the Hot-Plug-Detect signal status of all inputs.
EDIDMODE x y	Set the EDID mode of input (x: 01~32) to (y:1~2).
EDIDMODEALL x	The EDID mode of All Input to (x:1~2) .
EDIDPORT x y	Set the EDID mode of Assigned Port (y:01~32) to Input(x:01~32).
EDIDPORTALL x	The EDID mode of All ports is assigned to Output (x:01-32).
EDIDSTATUS	Report the status of the EDID Modes of all input ports.
UART x y "str"	Write UART string to output port(x:in/out, y:01~32, "str":"string").
UARTBAUD x y	Set the UART Baud rate of output port (x:01~32) (y:rate).
STATUSUART	Show output port UART baud rate.
TEMPSTATUS	Show temperature sensor values y1, y2.
SETIPADDR	Set the IP address (x.x.x.x).
SETSNMASK	Set the subnet mask (x.x.x.x).
SETGWADDR	Set the gateway IP address (x.x.x.x).
IPCONFIG	Display the current IP configuration.
RSTIP	Reset the IP Configuration Reset To Default values (DHCP).
BUZZER x	Mute the Buzzer (mute=0, UnMute=1).

Command	Description
REBOOT	Reboot the System.
SAVETO x	Save as Preset x(1~10).
RECALLTO x	Recall Preset x(1~10).
RESET	System Reset to O1I1,O2I2,O3I3,O4I4,O5I5....
VERSION	Display controller firmware version.

Note: Commands will be not executed unless followed by a carriage return.
Commands are not case-sensitive

6.5 RS-232 & IP to RS-232 RX Output Configuration

1. To check the Baud rate of a port, the command is STATUSUART. (Default is 19200bps)
2. To set the Baud rate, the command is UARTBAUD x y (x= output port 01~16, y= Baud rate), e.g to set the baud rate of Output 8 to 115200 bps you would send the command 'UARTBAUD 08 115200'.
3. To send a string to the RX side, the command is UART x "y" (x= output port 01~16, y= the string which you want to send to RX side), e.g. to send the string P0 to Output 12 you would send the command UART 12 "P0". In this example P0 is a common power command.
4. You would use the same procedure for sending IP Telnet to RS-232 commands.

6.6 Telnet Control

Before attempting to use the telnet control, please ensure that both the Matrix (via the 'LAN /CONTROL' port) and the PC/Laptop are connected to the active networks.

To access the telnet control in Windows 7, click on the 'Start' menu and type "cmd" in the Search field then press enter.

Under Windows XP go to the 'Start' menu and click on "Run", type "cmd" with then press enter.

Under Mac OS X, go to Go→Applications→Utilities→Terminal

See below for reference.

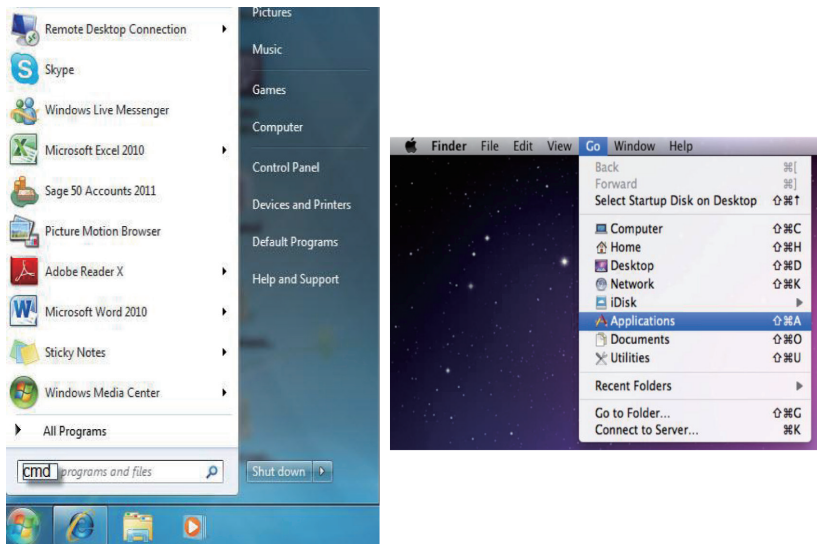

Once in the command line interface (CLI) type "telnet", then the IP address of the unit and "23", then hit enter.

Note: The IP address of the Matrix can be displayed on the device's LCM monitor by pressing the Menu button twice.

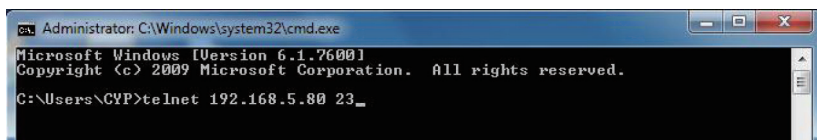

This will bring us into the device which we wish to control. Type "HELP" to list the available commands.

```

Telnet 192.168.5.139
Welcome to CYP Matrix TELNET.

telnet-> help

          P0 : Power Off
          P1 : Power On
          RESET : System Reset to 0111,0212,0313,0414,0515....
          OxxIxx(x:01~8) : Output 0~8 set to Input 1~8
          ALLOUT xx(x:01~8) : All Output set to Input 1~8
          MUTE xx(x:0~8) : Video mute command at output interface
          UNMUTE xx(x:0~8) : Video unmute command at output interface
          MUTEALL : Mute all outputs
          UNMUTEALL : Unmute all outputs
          SHOWMUTE : Show mute status of all output(0=not muted,1=muted)
          RDMUTE xx(x:0~8) : Read MUTE Status at Output
          HPDL0W xx(x:01~8) : Pull the Hot-Plug-Detect signal to 'LOW'
          HPDHIGH xx(x:01~8) : Pull the Hot-Plug-Detect signal to 'HIGH'
          HPDL0W ALL : Set All Input HPD to Low
          HPDHIGH ALL : Set All Input HPD to High
          SHOWHPD : Report ALL Input Hot-Plug-Detect signal status
          STATUSHPD x(x:1~8) : Show HPD status of input(x)
          SHOWTEMP : Show temperature sensor values y1, y2
          STATUSIN xx(x:01~8) : Report Input connection status
          STATUSOUT xx(x:0~8) : Report Output connection status
          STATUSALL : Report ALL Output connection status
          STATUSEDID : Report ALL Input EDID mode&port
          SETEDIDMODE ii mm(ii:01~8 mm:1~3) : Set EDID mode(mm) to Input(ii)
          SETEDIDMODE ALL mm (mm=1~3) : The EDID mode(mm) of All Input(ii)
          SETEDIDPORT ii pp(ii:01~8 pp:01~8) : Set EDID Assigned Port(pp) to Input(ii)
          SETEDIDPORT ALL mm (pp=01~8) : The EDID of All Inports is assigned to Output
          pp
          ACTIVE : Report I/O active channels
          INDETECT : Input channels detect indicator
          OUTDETECT : Output channels detect indicator
          IPCONFIG : Display the current IP config
          SETIP <IP> <SubNet> <GW> : Setting IP,ShuNet,Gateway(Static IP)
          RSTIP : IP Configuration Was Reset To Factory Defaults(DHCP)
          SETIPADDR <IP> : Setting IP address
          SETSNMASK <SubNet> : Setting subnet mask
          SETGWADDR <GW> : Setting gateway IP address
          R
  
```

Type "IPCONFIG" To show all IP configurations. To reset the IP, type "RSTIP" and to use a static IP, type "SETIP" (For a full list of commands, see Section 6.4).

Note: Any commands will not be executed unless followed by a carriage return. Commands are case-insensitive. If the IP is changed then the IP Address required for Telnet access will also change accordingly.

6.7 Web GUI Control

On a PC/Laptop that is connected to the same active network as the Matrix, open a web browser and type the device's IP address on the web address entry bar. The browser will display the device's status, control and User setting pages.

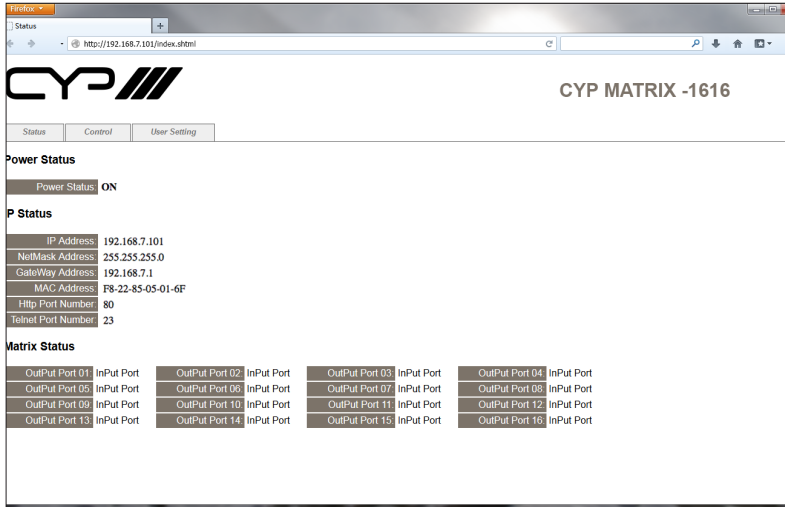

Click on the 'Control' tab to control power, input/output ports, EDID and reset mode.

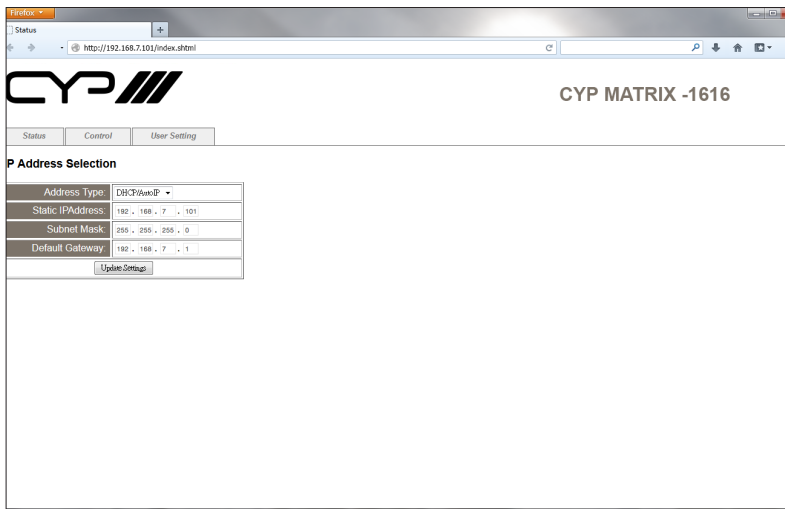

Clicking on the 'User Setting' tab allows you to reset the IP configuration. The system will ask for a reboot of the device every time any of the settings are changed. The IP address needed to access the Web GUI control will also need to be changed accordingly on the web address entry bar.

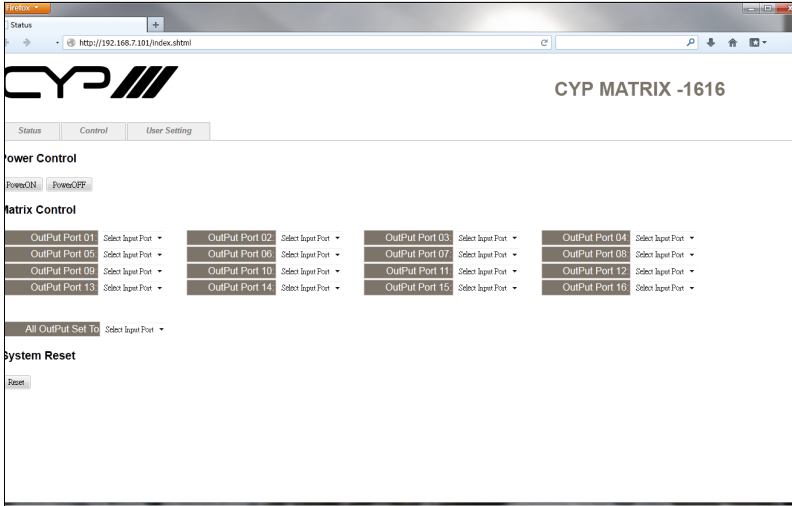

7. CONNECTION DIAGRAM

7.1 Example installation (16x16 HDMI Matrix)

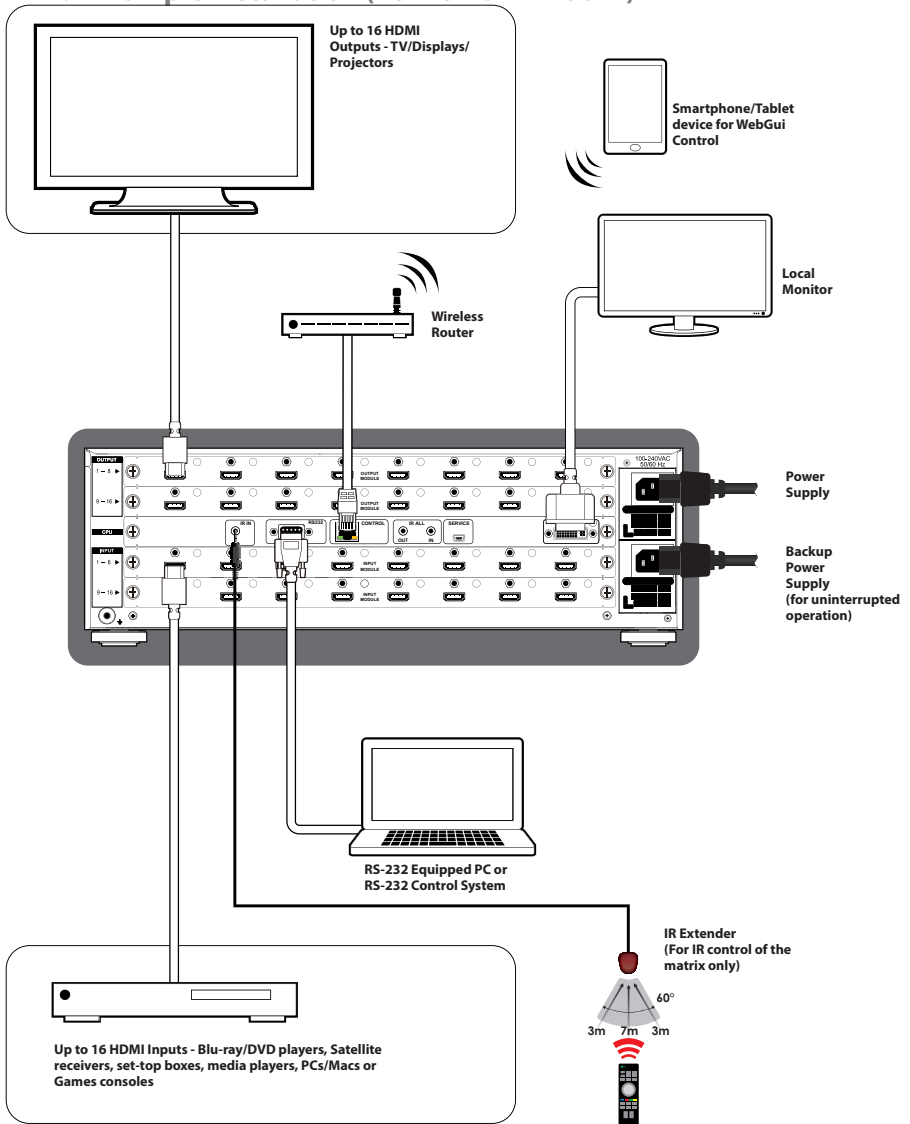

7.2 Input and Output Modules

Output Modules (x2)

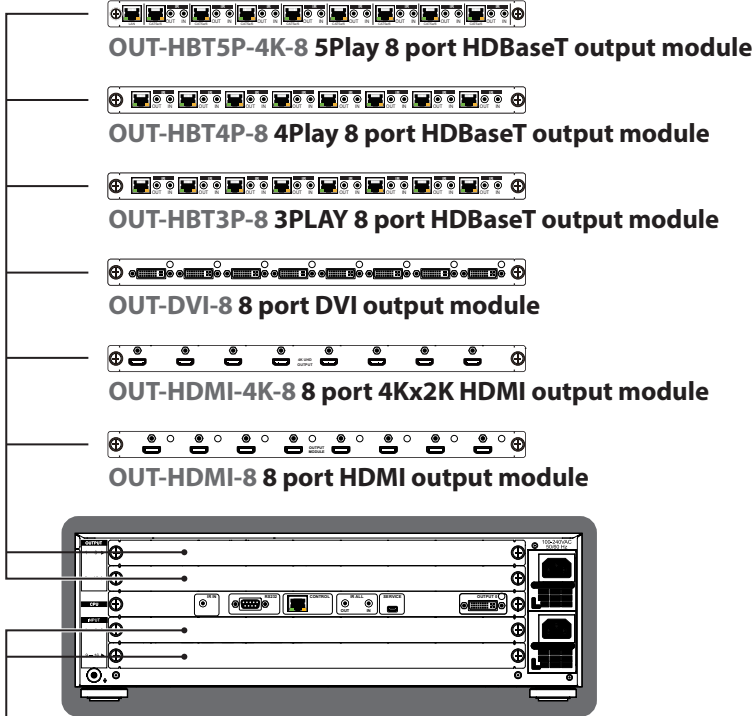

Input Modules (x2)

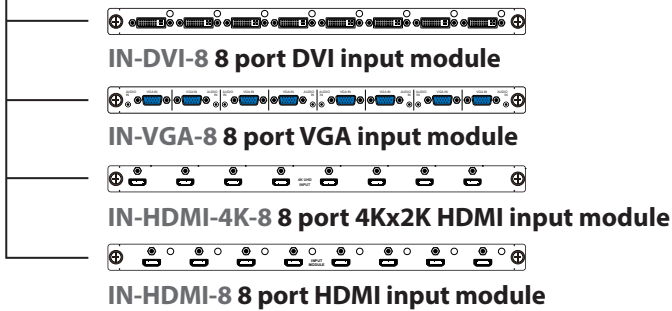

8. SPECIFICATIONS

8.1 Technical Specifications

Input ports	Up to 16× HDMI or DVI or CAT5e/6/7 or VGA) dependent on module configuration
Output ports	Up to 16× HDMI or DVI or CAT5e/6/7 dependent on module on module configuration
Power Supply	2× AC 110~240V (US/EU standards, CE/FCC/UL certified)
HMDI Cable I/O Distance	15m/8-bits, 10m/12-bits
Dimensions (mm)	482(W) × 484(D) × 145(H)
Weight	14.4 kg
Chassis Material	Metal
Colour	Black
Operating Temperature	0 °C~40 °C/32 °F~104 °F
Storage Temperature	-20 °C~60 °C/-4 °F~140 °F
Relative Humidity	20~90% RH (non-condensing)
Power Consumption	130W

8.2 Technical Specifications (Input Modules)

IN-HDMI-8 8 Port HDMI Input Module	
Video Bandwidth	225MHz/6.75Gbps
Input ports	8× HDMI
Video resolutions	PC: VGA ~WUXGA@60RB HD: 480i~1080p
Audio transmission	LPCM7.1CH, Dolby TrueHD, Dolby Digital Plus, DTS-HD Master Audio (32~192KHz Fs sample rate)

IN-DVI8 8 Port DVI input module	
Video Bandwidth	225MHz/6.75Gbps
Input ports	8× DVI
Video resolutions	PC: VGA ~WUXGA@60RB HD: 480i~1080p
Audio transmission	LPCM7.1CH, Dolby TrueHD, Dolby Digital Plus, DTS-HD Master Audio (32~192KHz Fs sample rate)

IN-VGA8 8 Port VGA input module	
Input ports	8× VGA, 8× 2.5mm Audio phone jack
Video resolutions	PC: VGA ~WUXGA@60RB
Audio transmission	Stereo 2.5mm phone jack (included 2.5mm to 3.5mm adaptor)

IN-HDMI-4K-8 8 Port 4Kx2K HDMI input module	
Video Bandwidth	25~340MHz
Input ports	8× HDMI
Video resolutions	PC: VGA ~WUXGA HD: 480i~1080p, 4Kx2K@30Hz, 4Kx2K@50/60 (4:2:0)
Audio transmission	LPCM7.1CH, Dolby TrueHD, Dolby Digital Plus, DTS-HD Master Audio (32~192KHz Fs sample rate)

8.3 Technical Specifications (Output Modules)

OUT-HDMI-8 8 Port HDMI output module	
Video Bandwidth	225MHz/6.75Gbps
Input ports	8× HDMI
Video resolutions	PC: VGA ~WUXGA@60RB HD: 480i~1080p
Audio transmission	LPCM7.1CH, Dolby TrueHD, Dolby Digital Plus, DTS-HD Master Audio (32~192KHz Fs sample rate)

OUT-DVI8 8 Port DVI output module	
Video Bandwidth	225MHz/6.75Gbps
Output ports	8× DVI
Video resolutions	PC: VGA ~WUXGA@60RB HD: 480i~1080p
Audio transmission	LPCM7.1CH, Dolby TrueHD, Dolby Digital Plus, DTS-HD Master Audio (32~192KHz Fs samplerate)

OUT-HDMI-4K-8 8 Port 4Kx2K HDMI output module	
Video Bandwidth	25~340MHz
Output ports	8× HDMI
Video resolutions	PC: VGA ~WUXGA HD: 480i~1080p, 4Kx2K@30Hz, 4Kx2K@50/60 (4:2:0)
Audio transmission	LPCM7.1CH, Dolby TrueHD, Dolby Digital Plus, DTS-HD Master Audio (32~192KHz Fs samplerate)

OUT-HBT3P-8 8 Port HDBaseT output module	
Video Bandwidth	225MHz/6.75Gbps
Features	Support HDBaseT/IR/RS232
Output ports	8× CAT5e/6, 8× IR Extender, 8× IR Blaster
Video resolutions	PC: VGA ~ WUXGA
IR Frequency	30~50Hz
Audio transmission	LPCM7.1CH, Dolby TrueHD, Dolby Digital Plus, DTS-HD Master Audio (32~192KHz Fs samplerate)

OUT-HBT4P-8 8 Port HDBaseT output module	
Video Bandwidth	225MHz/6.75Gbps
Features	Support HDBaseT/PoC/IR/RS232
Output ports	8× CAT5e/6, 8× IR Extender, 8× IR Blaster
IR Frequency	30~50Hz
Video resolutions	PC: VGA ~ WUXGA HD: 480i~1080p
Audio transmission	LPCM7.1CH, Dolby TrueHD, Dolby Digital Plus, DTS-HD Master Audio (32~192KHz Fs samplerate)

OUT-HDBT-4K-8 8 Port HDBaseT output module	
Video Bandwidth	300MHz/10.2Gbps
Features	Support HDBaseT/PoC/IR/RS232/Ethernet
Output ports	8× CAT5e/6, 8× IR Extender, 8× IR Blaster, 1× LAN
Ethernet Speed	100Mbps
Video resolutions	PC: VGA ~WUXGA HD: 480i~1080p, 4Kx2K@30Hz, 4Kx2K@50/60 (4:2:0)
IR Frequency	30~50Hz
Audio transmission	LPCM7.1CH, Dolby TrueHD, Dolby Digital Plus, DTS-HD Master Audio (32~192KHz Fs sample rate)

8.4 CAT5e/6/7 Cable Specification

OUT-HBT3P-8 CABLE DISTANCE

Cable Type	Range	Pixel clock rate	Video Data Rate	Supported Video
CAT5E/6/7	60 m	<=225 MHz	<=5.3 Gbps (HD Video)	Up to 1080p, 60 Hz, 36 bits, 3D (data rates lower than 5.3 Gbps or below 225 MHz TMDS clock).

OUT-HBT4P-8/OUT-HBT5P-4K-8 CABLE DISTANCE

Cable Type	Range	Pixel clock rate	Video Data Rate	Supported Video
CAT5E/6/7	100 m	<=225 MHz	<=5.3 Gbps (HD Video)	Up to 1080p, 60 Hz, 36 bits, 3D (data rates lower than 5.3 Gbps or below 225 MHz TMDS clock).
	70 m	>225 MHz	> 5.3 Gbps (Ultra HD Video)	4K2K, 30Hz video & 4Kx2K@50/60 (4:2:0) formats

9. ACRONYMS

ACRONYM	COMPLETE TERM
CLI	Command Line Interface
DTS	Digital Theater System
DVI	Digital Visual Interface
EDID	Extended Display Identification Data
GUI	Graphical User Interface
HDCP	High-bandwidth Digital Content Protection
HDMI	High-Definition Multimedia Interface
HDTV	High-Definition Television
LCM	Liquid Crystal Module
PoC	Power over Cable
VGA	Video Graphics Array
WUXGA	Widescreen Ultra Extended Graphics Array



CYP (UK) Ltd., Unit 7, Shepperton Business Park, Govett Avenue, Shepperton,
Middlesex, TW17 8BA

Tel: +44 (0) 20 3137 9180 | Fax: +44 (0) 20 3137 6279

Email: sales@cypeurope.com

www.cypeurope.com

v1.02